

November 2021

## Description

Designed specifically for demanding industrial applications, the **NET Concentrator System® (NCS)** provides a real-time signal gateway between the field or factory floor and your control strategy.

### Complete Monitoring and Control Networks

The NCS is the ideal solution when you need to network new and existing “legacy” process sensors, instruments and final control elements with computer-based monitoring and control systems. Universal and modular, it programs to handle a wide range of signal input and control output possibilities:

- **Current • Voltage • Discrete • Relay • RTD**
- **Thermocouple • Resistance • Potentiometer**

### Simultaneous Ethernet and Dual MODBUS RTU (Master/Slave) Communications

The NCS comes standard with one Ethernet (MODBUS/TCP) port and dual, independent MODBUS RTU (RS-485) ports. One or both of the MODBUS ports can be configured as MODBUS master ports. This allows the NCS to poll other MODBUS RTU slaves with all of the network polling functions of a typical MODBUS master.

**Figure 1.** The NCS links new and existing “legacy” process equipment with DCS, PLC and PC-based HMI/SCADA strategies.

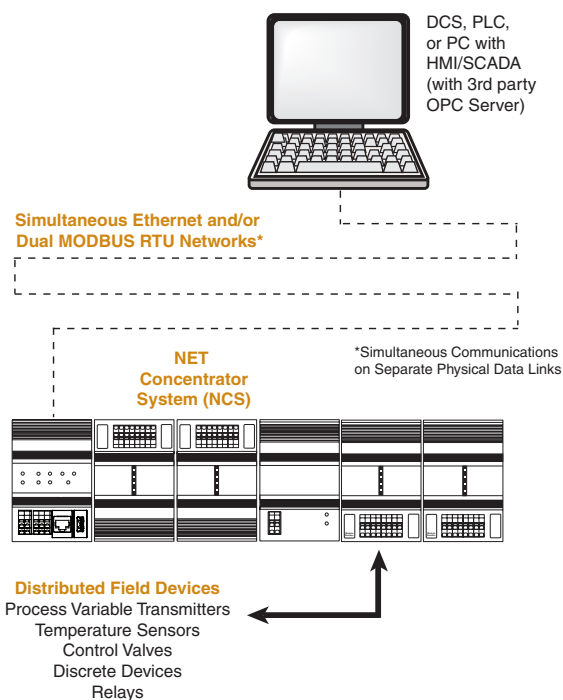

Certifications (see Page 16)



Rugged metal construction delivers superior RFI/EMI protection and stands up to the daily rigors of demanding process and factory automation applications.

## Features

- **Superior 20-bit input and 18-bit output resolution.** Matches or exceeds the accuracy of the most precise process transmitters on the market, easily surpassing the specifications claimed by other I/O systems.
- **Installs in harsh ambient temperature conditions.** An operating range of -40°C to +85°C (-40°F to +185°F) permits installation in locations well outside the capabilities of comparable systems.
- **Quick and simple programming.** Using a web browser or Moore Industries’ free Intelligent PC Configuration Software, operating parameters can be viewed, selected, and set in minutes. Multipoint Analog Alarm option provides easy alarm programming for up to 32 inputs.
- **Isolation and RFI/EMI protection.** Eliminates unpredictable ground loops and protects against the harmful effects of plant electrical “noise”.
- **Peer-to-Host and Peer-to-Peer operation.** Flexible architecture provides versatile application options.
- **Transmit any distance, over any terrain.** Use a twisted wire pair, Ethernet cabling, wireless, or fiber optics to overcome rugged, long-distance, normally impassable, and hazardous environments.
- **Data logging capabilities.** Up to 64,000 points of time-stamped data can be stored and retrieved.

# NCS

NET Concentrator System®  
Process Control and Distributed I/O

## New Installations and “Legacy” Retrofit Applications

The NET Concentrator System (NCS) is ideal for creating new monitoring and control networks. It is also perfect when you want to leave existing “legacy” sensors, analog instruments and valves in place, yet still take advantage of digital signal transmission.

The NCS can be used to send just a few, or hundreds, of process signals between the field and your control system. Industrially-hardened and configurable I/O stations mount throughout a site or in dispersed locations throughout the world to provide cost-effective distributed data acquisition and control.

### Save Thousands on Installation Costs

The NCS saves time and money when used in place of hard-wired schemes. Concentrate just a few, or hundreds, of process signals onto a single digital data link. You’ll save the cost of cable, conduit, connection and wire tray costs. You can even use an existing Ethernet network and eliminate the time and expense of creating a new network. The NCS also simplifies overall system design, installation and maintenance.

## Table of Contents

<b>System Architectures</b>	2-4
Peer-to-Host Systems	2-3
Peer-to-Peer Systems	4
MODBUS Master Systems	5
<b>System Advantages</b>	6
<b>Module Types</b>	7
<b>Ordering Information</b>	8
<b>Specifications</b>	9-15
EMM Ethernet/MODBUS Interface Module	9
AIM Analog Input Module	10
AOM Analog Output Module	11
TIM Temperature Input Module	12-13
DIM Discrete Input Module (Contact Closure or Voltage)	14
ROM Relay Output Module	14
CPM Concentrator Power Supply Module	15
<b>Advanced Control and Math Functions</b>	10
<b>Data Link Options</b>	11
<b>Installation Dimensions</b>	15
<b>Agency Certifications</b>	16
<b>System Accessories</b>	16

## System Architecture

NET Concentrator System networks are made up of one or more stand-alone I/O stations consisting of one EMM Ethernet/MODBUS Interface Module, combined with Input and/or Output Modules. Any combination of Input and Output Modules may be used within a NET Concentrator System network. The NCS comes standard with one Ethernet (MODBUS/TCP) port and dual MODBUS RTU (RS-485) ports. The system will work in both **Peer-to-Host** and **Peer-to-Peer Systems**.

### Peer-to-Host Systems

Peer-to-Host Systems provide a cost-effective method to transfer monitoring and control signals to and from a host DCS, PLC or PC-based system. In this architecture, NET Concentrator System stations are distributed along an Ethernet (MODBUS/TCP) network and/or one or two MODBUS RTU serial networks. Once the data is delivered to the host system, third-party HMI or SCADA software packages can be used to create user interface strategies that may include data acquisition, alarm summary and management, data logging and reporting, historical data collection and trending and supervisory control functions.

### Ethernet (IEEE 802.3) Networks

The number of NET Concentrator System (NCS) stations that can be used on an Ethernet (MODBUS/TCP) network is limited only by the architecture of a specific network\*. Standard industrial Ethernet switches or hubs are available to interconnect large numbers of NCS stations. Ethernet switches also minimize message collisions, improving determinism in the NCS Ethernet network (Figure 2).

### Standard Dual MODBUS RTU Networks

When the NCS uses MODBUS RTU (RS-485) for communications, each of the dual MODBUS RTU ports can be programmed to act as a master or slave within a network (each port is configured by the factory as a MODBUS slave port). Up to 32 (without repeaters) NET Concentrator System slave stations and/or third-party slave devices per dual port can be distributed throughout a plant multidropped on the MODBUS RTU data link(s). The NCS will handle up to 64 slave devices if both MODBUS ports are used. Depending on the type of I/O modules used, a station can accommodate as few as four or as many as 128 points\*\*.

\*Taking into account the physical limitations of Ethernet. Consult the factory for details.

\*\* The number of available channels differs from NCS module to module. See “Ordering Information” on Page 7 for details.

A fully populated NET Concentrator System, using the dual port MODBUS capability, handles up to 8,192 points. With repeaters, additional NCS stations can be added to a system. All that is required for interface with a PC-based system is one (or two if both ports are used) internal RS-485 communication port or a RS-485-to-RS-232 converter.

discrete devices such as alarm trips or limit switches. It concentrates the signals and, when polled by the network master, sends them over the Ethernet or MODBUS RTU (RS-485) network directly to the computer-based host.

For control, process commands from the host are transmitted over the network to the NCS, which converts the commands to analog or discrete form to control valves, pumps, motors and any other type of proportional or on/off control element.

## Distributed Monitoring and Control

For monitoring applications, the NCS collects signals from analog transmitters (4-20mA, 0-10V, etc.) or

**Figure 2.** In Peer-to-Host Systems, multiple NET Concentrator System stations network to handle just a few, or hundreds, of signal inputs and outputs.

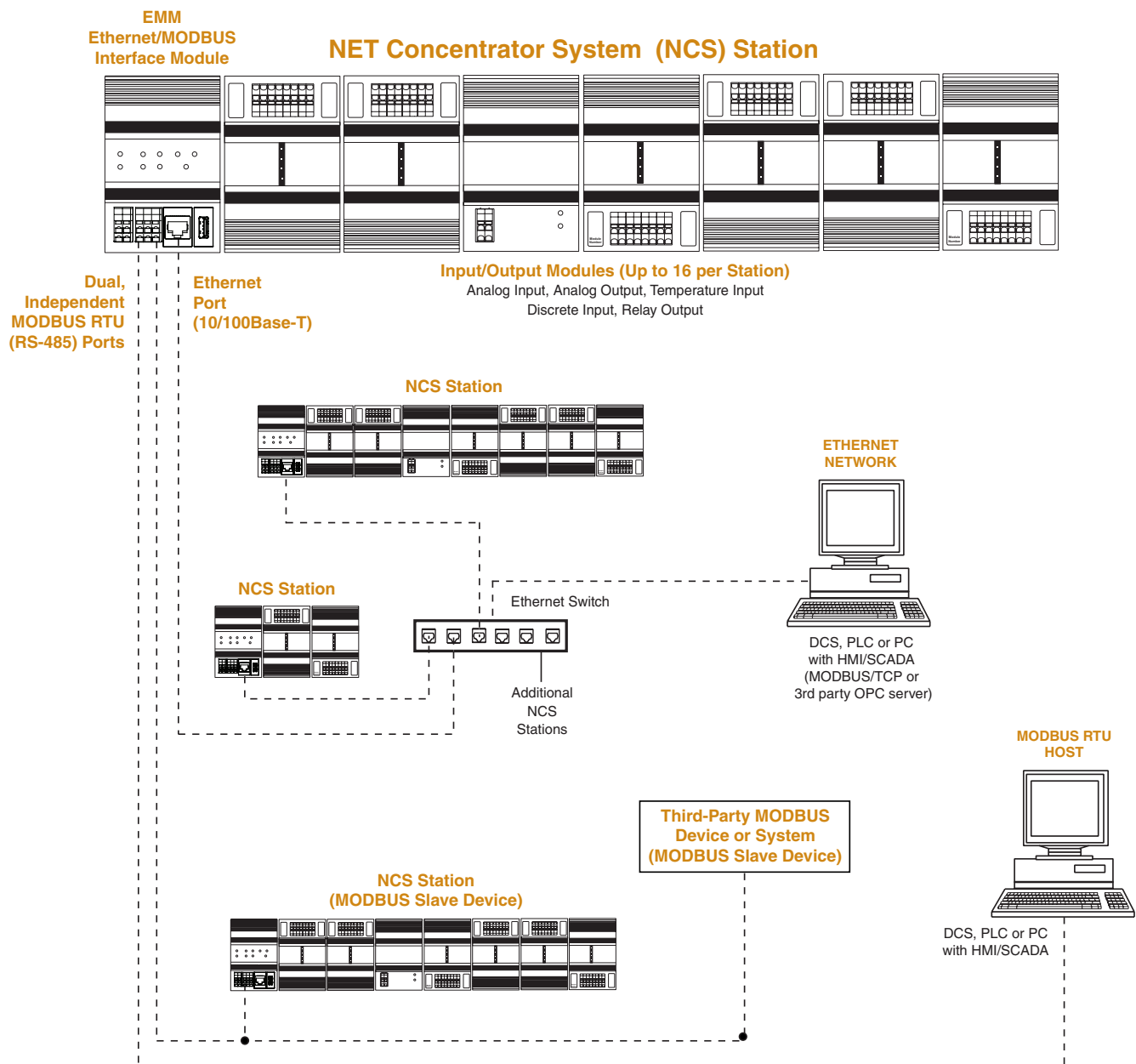

# NCS

NET Concentrator System®  
Process Control and Distributed I/O

## Peer-to-Peer Systems

In this architecture, NCS stations are used to “concentrate” analog and discrete monitoring and control signals onto a digital data link. This dramatically reduces the cost of transmitting multiple signals long distances by eliminating the need for costly point-to-point wiring.

## Distributed Monitoring and Control

Whether for control or data acquisition, the Peer-to-Peer architecture enables signals to be shared across the entire plant economically by digitally concentrating multiple signals over a single communication medium. For example, an AIM Analog Input Module accepts signals from multiple analog transmitters and concentrates the signals onto the digital data link for transmission. Then, an AOM Analog Output Module at the opposite end of the link returns the signals to their original analog form (or to any proportional form).

## Peer-To-Peer Ethernet Systems

Ethernet Peer-to-Peer Systems are accomplished using the EMM Interface Module combined with ISaGRAF control software (available from Moore Industries). ISaGRAF software configuration is mandatory for all Ethernet based Peer-to-Peer systems. See Page 10 for

additional information.

## Peer-To-Peer RS-485 Systems

Each NCS station can have a maximum of six I/O modules in a RS-485 Peer-to-Peer System. These stations are configured utilizing the EMM’s internal web pages with Internet Explorer web browser or via the free Moore Industries software package called NCS Config. ISaGRAF software is NOT required for these systems.

## Arrange Stations in Matching Pairs or Use Free Channel Mapping

**Matching Pairs**—NCS Peer-to-Peer Systems are typically comprised of NCS station pairs, with the signals from an Input Module within a station sending signals to an Output Module within another station (such as one on the opposite side of the data link).

**Free Channel Mapping**—Alternatively, each NCS input/output channel in a Peer-to-Peer System can be mapped (assigned) to any other channel within a system. Requires ISaGRAF or the use of MODBUS Master (see page 5).

**Send One Signal to Multiple Locations**—One channel can also be assigned to any number of other channels should multiple identical representations of an input or output signal be required at different locations.

**Figure 3A.** A Peer-to-Peer system over Ethernet allows full channel mapping flexibility across the entire network and requires the use of ISaGRAF control software (available from Moore Industries).

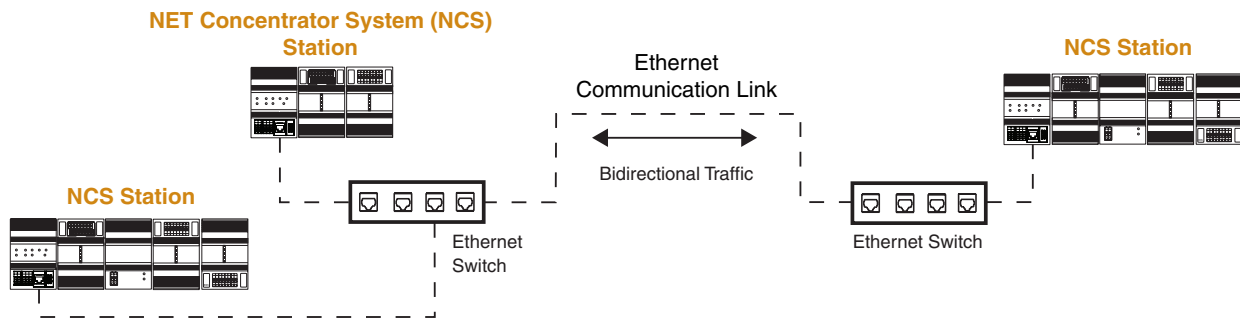

**Figure 3B.** A Peer-to-Peer system using the EMM’s RS-485 ports is typically configured to have matching pairs, with compatible modules, that send data back and forth across the network.

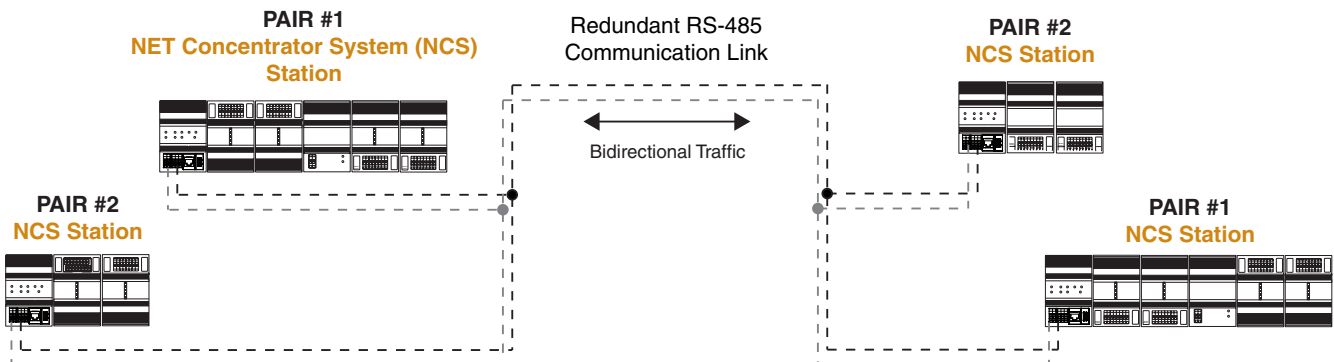

## MODBUS Master Systems

The two RS-485 ports on the EMM Interface Module can act as independent MODBUS RTU slaves, masters, or in Peer-to-Peer mode. The NCS MODBUS Master mode only applies to the MODBUS RTU ports. It is not applicable to the MODBUS/TCP (Ethernet) port.

## Simple Setup and Configuration

Configuration of MODBUS Master capability is accomplished by using the EMM's internal web pages with Internet Explorer web browser or via the free Moore Industries software package called NCS Config. Additionally a text file named "Schedule.ini" has to be created and uploaded to the EMM. The Schedule.ini file is a simple text file, created with any text editor such as Notepad, that instructs the NCS where and what data to read/write using the MODBUS RTU RS-485 port(s).

## MODBUS Data Transfer

With its MODBUS Master capability, the NCS allows:

MODBUS RTU slave data acquisition, dynamic channel mapping, control, and even gateway functions.

**Data Acquisition**—Any MODBUS RTU slave device from Moore Industries or any other vendor can be polled by the NCS utilizing either one or both of the two RS-485 ports.

**Channel Mapping**—Read/Write any data to and from any MODBUS RTU device; on either of the EMM's RS-485 ports.

**Control**—If any connected MODBUS RTU slave device has relay or analog output capability the NCS can write process values down to that device for control or alarming applications.

**Gateway Functions**—Often newer host systems can communicate via MODBUS/TCP over Ethernet but not MODBUS RTU. The MODBUS Master feature allows the EMM to act as a MODBUS/TCP to MODBUS RTU gateway by bi-directionally sharing data between the two different networks.

**Figure 4.** The built-in MODBUS Master capability allows the NCS to read and write any process variable data points to and from MODBUS RTU slave devices.

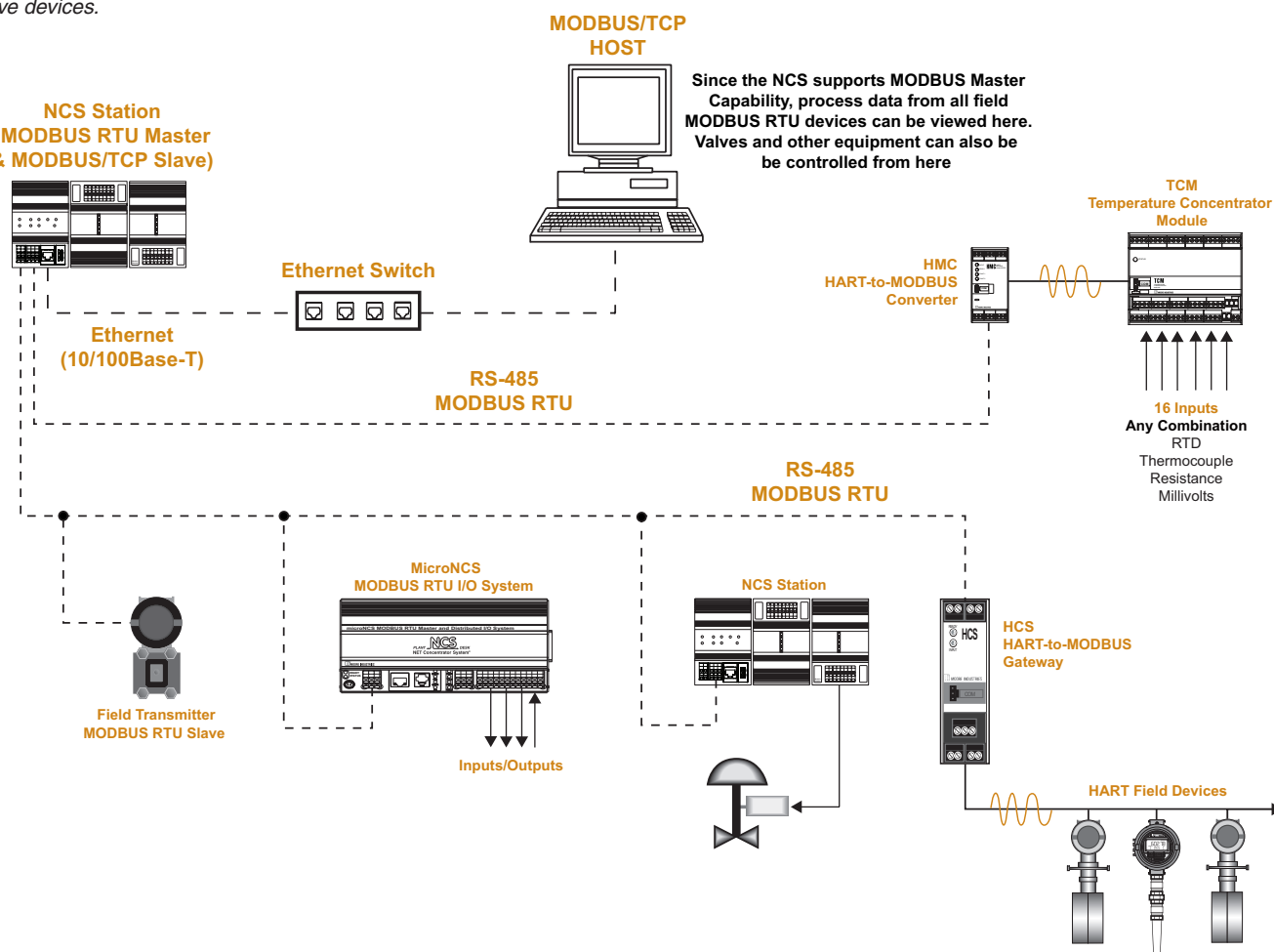



# NCS

NET Concentrator System®  
Process Control and Distributed I/O

## System Advantages

**Fast and Simple Set Up**—The NET Concentrator System includes a Web server utility that allows configuration and real time viewing of process data via Internet Explorer Web browser over your Intranet (or Internet) from any PC, with proper security password clearance. Alternatively our free Intelligent PC configuration software, NCS Config, can also be used for programming and viewing of real time process data via the Ethernet port.

**Custom Linearization**—The NET Concentrator System can be programmed with up to 128 custom linearization points for each input channel. The ability to plot a custom linearization curve is beneficial when non-linear signals must be converted to linear output representations. Typical applications include monitoring a non-linear transducer, the level of odd-shaped tanks and flow meter linearization.

**Compatible with HMI and SCADA Software**—Once the data is delivered to the host PC or DCS, leading third-party HMI software packages can be used to create custom data acquisition and control strategies. These packages allow a multitude of functions including alarm summary and management, data logging and reporting, historical data collection and trending and supervisory control functions.

Figure 5. Up to 128 custom linearization points can be selected and saved in memory to compensate for non-linear input signals.

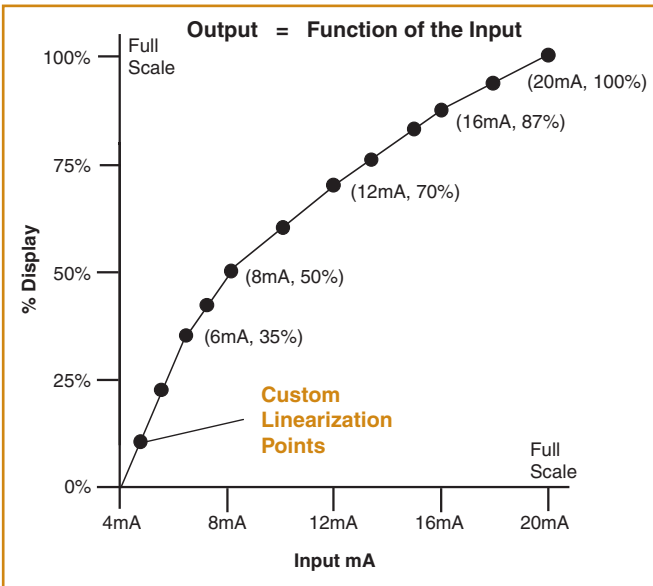
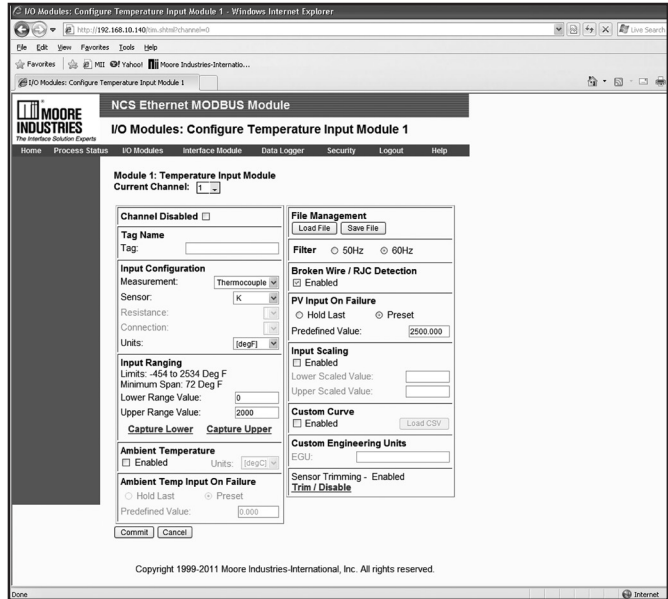

Figure 6. Point-and-click configuration software allows I/O channels and system parameters to be programmed in minutes.



**Data Logging with Battery Back-Up**—NCS stations are capable of storing 64,000 points of time-stamped data (the most recent 18,000 samples are backed up via battery). A station can be configured to store data from one or all of its input channels. Sampling rate is user-selectable for any period between once every 100 milliseconds, to once every 24 hours.

**Powers the 4-20mA Loop**—To facilitate the transition from 4-20mA wires to digital communications, the NET Concentrator System's Analog Input Module (AIM) supplies power to existing or new 2-wire analog transmitters that must be powered by the process loop.

**On-Line Diagnostics Speeds Troubleshooting**—The NCS continuously monitors its inputs, the data link and itself to identify and report potential problems to the control system.

**Precise Digital Input and Output Trimming**—To produce highly accurate readings, Input/Output Modules can be precisely trimmed to essentially eliminate measurement errors introduced by the input (such as a RTD or T/C sensor errors) and compensate for readout device inaccuracies.

## Module Types

NET Concentrator System (NCS) networks are made up of one or more stand alone stations consisting of one Interface Module, combined with just one, or up to 16, Input and/or Output Modules. Any combination of Input and Output Modules may be used in a NCS network.

### Modular and Expandable

To provide maximum flexibility and expandability, the NCS's modular design allows any combination of Input and Output Modules to be matched with an Interface Module (up to 16 I/O Modules per Interface Module). To accommodate changing site requirements, I/O Modules can be added or removed from a NCS, and additional stations can be added to a network at any time.

### “Hot Swappable” I/O Modules

Should an Input/Output Module need to be replaced, simply program a new module, remove the old module from the mounting base, snap in the new one, and you're up and running.

**Figure 7.** Modular design allows quick and simple “hot swap” replacement of plug-in Input and Output Module electronics.

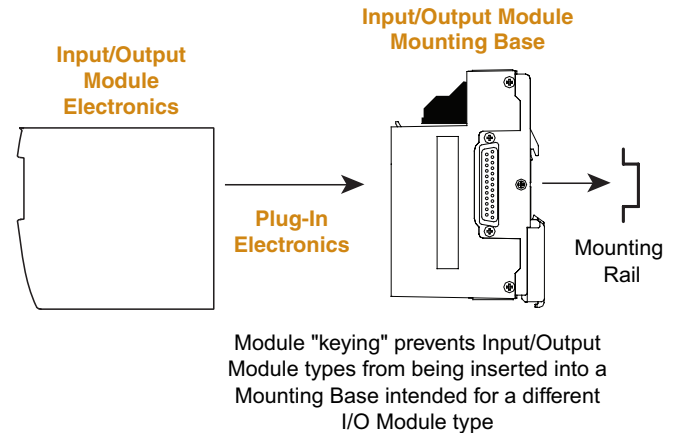

**Important Note:** The EMM Ethernet/MODBUS Interface Module provides power for up to two Input and/or Output Modules. If more than two I/O Modules will be connected to the Interface Module, a CPM Concentrator Power Module is required. The CPM may be installed at any position within an NCS station. It works in conjunction with the Interface Module to power NCS stations of up to eight I/O Modules. If 16 I/O Modules are used in an NCS station, two CPMs will be needed. The CPM will only power units that are mounted to **its** left (from the user's front view perspective, this would be the right side of the CPM).

**Figure 8.** NET Concentrator System stations consist of one Interface Module combined with up to 16 Input/Output Modules.

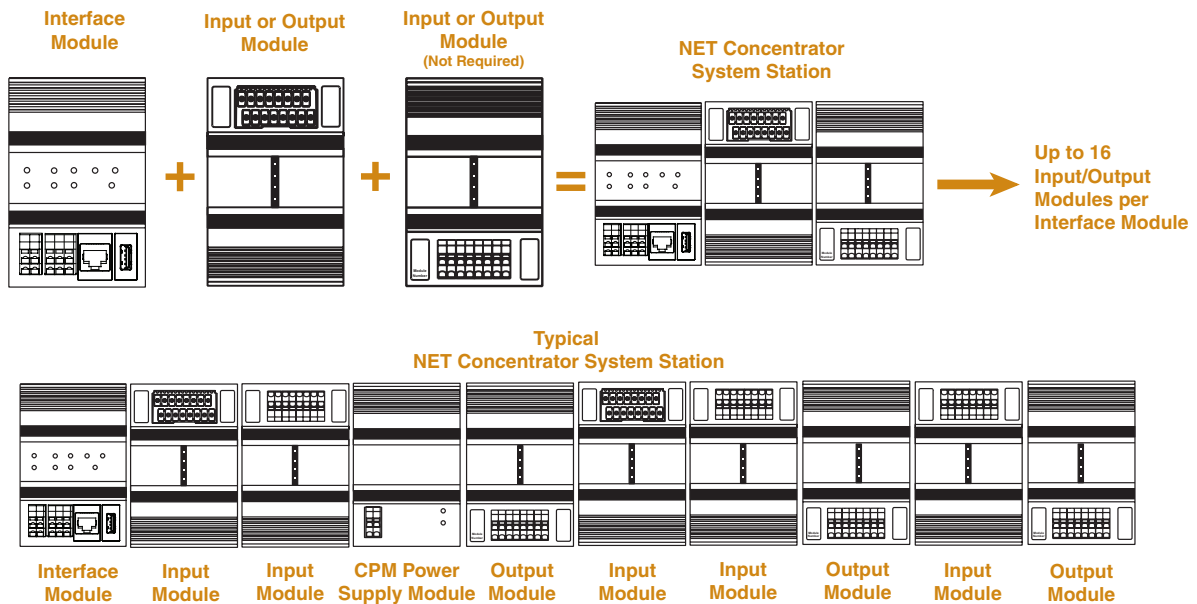

The CPM may be installed at any position within an NCS station. It works in conjunction with the EMM Interface Module to power NCS stations of up to eight I/O Modules. If 16 I/O Modules are used in an NCS station, two CPMs will be needed. The CPM will only power units that are mounted to **its** left (from the user's front view perspective, this would be the right side of the CPM).

**NOTE:**

1. Terminal blocks can accommodate 12-28 AWG (2.08-0.33 mm<sup>2</sup>) solid wiring.
2. Tighten terminals to 4 in-lb (0.45 Nm), maximum.

# NCS

NET Concentrator System®  
Process Control and Distributed I/O

## Ordering Information

Unit	Module Type	Input/Output Configuration	Power	Options	Housing
<b>INTERFACE MODULE (One Required Per NET Concentrator System Station)</b>					
<b>EMM</b> Ethernet/MODBUS Interface Module	<b>COM</b> Communication Module	<b>SM</b> Up to 16 Input/Output Modules  <b>Important Note:</b> The EMM Interface Module provides power for up to two Input and/or Output Modules. If more than two I/O Modules will be connected to the Interface Module, a CPM Concentrator Power Module is required. The CPM may be installed at any position within an NCS station. It works in conjunction with the Interface Module to power NCS stations of up to eight I/O Modules. If 16 I/O Modules are used in an NCS station, two CPMs will be needed. The CPM will only power units that are mounted to its left (from the user's front view perspective, this would be the right side of the CPM).	<b>20-30DC</b>	<b>-MAA Multipoint Analog Alarm</b> Requires 1 ROM module and at least 1 TIM or AIM module in the system	<b>DIN</b> Aluminum DIN-style rail-mount housing mounts on 35mm Top Hat (EN50022) rails
<b>INPUT/OUTPUT MODULES (Up to 16 Per Interface Module)</b>					
<b>AIM*</b> Analog Input Module	<b>IO</b> Input/Output Module	<b>AI4</b> Four Configurable Analog Input Channels (0-20mA, -10V to 10V)	<b>IP</b> Input and Output Modules are powered by the Interface Module	<b>-NB</b> Spare or replacement Input/Output Module Electronics <u>without</u> the Mounting Base <b>-NM</b> Spare or replacement Mounting Base <u>without</u> Input/Output Module Electronics	<b>DIN</b> Aluminum DIN-style rail-mount housing mounts on 35mm Top Hat (EN50022) rails
<b>AOM*</b> Analog Output Module	<b>IO</b> Input/Output Module	<b>AO4</b> Four Configurable Analog Output Channels (0-20mA, 0-10V)			
<b>TIM*</b> Temperature Input Module	<b>IO</b> Input/Output Module	<b>TI4</b> Four Configurable Temperature Input Channels (RTD, T/C, mV, ohms, Pot; see Table 1 for details)			
<b>DIM*</b> Discrete Input Module	<b>IO</b> Input/Output Module	<b>CC8</b> Eight Discrete Contact Closure Input Channels (24V/3.7mA, internally-powered)			
		<b>HV8</b> Eight Discrete Voltage Input Channels (High Range: 120/240Vac)			
		<b>LV8</b> Eight Discrete Voltage Input Channels (Low Range: 30Vac/Vdc)			
<b>ROM*</b> Relay Output Module	<b>IO</b> Input/Output Module	<b>RNC8</b> Eight (Normally Closed) Relay Output Channels, SPST relay, 1 form A, rated 2A@250Vac, 50/60Hz, non-inductive, or 2A@30Vdc	*Input/Output Modules come with a Mounting Base unless the <b>-NB</b> or <b>-NM</b> option is specified (see Figure 6).		
		<b>RNO8</b> Eight (Normally Open) Relay Output Channels SPST relay, 1 form B, rated 2A@250Vac, 50/60Hz, non-inductive, or 2A@30Vdc			
<b>POWER SUPPLY MODULE (One Required if More than TWO Input/Output Modules are in a NCS Station)</b>					
<b>CPM</b> Concentrator Power Module	<b>20-30DC</b>	<b>NCSPWR</b> Up to Eight I/O Modules (not required if only one or two I/O modules will be used with an EMM Interface Module)	<b>20-30DC</b>	No Options	<b>DIN</b> (see description above)

**To Order, Specify:** Unit / Module Type / Input or Output Configuration / Power / Options [Housing]

### NET Concentrator System Model Number Examples:

#### Example Station #1—Interface Module with One I/O Module

EMM / COM / SM / 20-30DC [DIN]  
TIM / IO / TI4 / IP [DIN]

#### Example Station #2—Interface Module with -MAA Option and Two I/O Modules

EMM / COM / SM / 20-30DC / -MAA [DIN]  
AIM / IO / AI4 / IP [DIN]  
ROM / IO / RNC8 / IP [DIN]

#### Example Station #3—Interface Module with CPM Concentrator Power Module and Seven I/O Modules

EMM / COM / SM / 20-30DC [DIN]  
CPM / 20-30DC / NCSPWR / 20-30DC [DIN]  
TIM / IO / TI4 / IP [DIN]  
AOM / IO / AO4 / IP [DIN]  
DIM / IO / HV8 / IP [DIN]  
AIM / IO / AI4 / IP [DIN]  
DIM / IO / CC8 / IP [DIN]  
ROM / IO / RNC8 / IP [DIN]  
ROM / IO / RNO8 / IP [DIN]



## Specifications

### EMM Ethernet Interface Module

One Interface Module Required Per NET Concentrator System Station

<p><b>Communications</b> <b>ETHERNET</b> <b>Ethernet Port:</b> 10/100Base-T supports speeds up to 100Mb/second. Standard RJ-45 Connection Auto negotiation, Auto MDIX, DHCP or fixed IP address <b>Protocol Type:</b> MODBUS/TCP <b>MODBUS</b> <b>Type:</b> Two independently configurable RS-485 ports (according to EIA-485, 1993) <b>Protocol Type:</b> MODBUS RTU <b>Baud Rates:</b> 1200, 2400, 4800, 9600, 19.2k, 38.4k and 57.6k (user-selectable; default is 9600) <b>Parity:</b> Even, Odd or No Parity (1 stop bit, fixed; default is No Parity) <b>Device Address:</b> 1-255 (Default is 1) <b>Character Timeout:</b> 5, 10, 25, 50, 100, 200 and 255 character times (user-selectable; factory set to 1.5 character times MODBUS RTU standard default) <b>Response Delay:</b> 5, 10, 25, 50, 100, 200 and 255 character times (user-selectable; factory set to 0 delay)</p>	<p><b>Performance (continued)</b> I/O module connected to the EMM) 3. Signal Response Time: Time to convert between physical I/O and digital signals (see specification for specific I/O type) <b>Isolation:</b> 1000Vrms between case, input, output, each MODBUS port, each discrete input channel and power, continuous, and will withstand a 1500Vac dielectric strength test for one minute (with no breakdown). 500Vrms between analog input channels. <b>Power Supply:</b> 20-30VDC <b>Power Consumption:</b> 24VDC power input, 13.0W max.</p>	<p><b>Status and Fault Indicators (continued)</b> <b>RX1:</b> Green blinks when Receive activity on MODBUS 1 occurs; Off when no Receive activity on MODBUS 1; Green solid when MODBUS 1 connection reversed <b>TX2:</b> Green blinks when Transmit activity on MODBUS 2 occurs; Off when no Transmit activity on MODBUS 2 <b>RX2:</b> Green blinks when Receive activity on MODBUS 2 occurs; Off when no Receive activity on MODBUS 2; Green solid when MODBUS 1 connection reversed</p>
<p><b>Performance</b> <b>Data Access Time:</b> Time to detect or effect a change in an I/O signal from a MODBUS master polling a EMM is the sum of 3 timing components: 1. Network Communication Time: Depends on network architecture and traffic. For a PC locally networked to a EMM, this time is negligible 2. Scan Time: Time required by the EMM to scan real-time data in all I/O modules connected to it (see <i>Module Scan Time</i> specification for each expansion I/O module type and add times for each</p>	<p><b>Status and Fault Indicators</b> <b>System:</b> <b>READY:</b> Green when ready; Off when not ready <b>STATUS:</b> Green when OK; Red when not OK <b>Ethernet:</b> For Firmware version 5.0.00 or later: <b>LINK/ACT:</b>This LED indicates transmit and receive activity in addition to the status of the Link. The LED will be ON when Link is good. It will blink when the transmitter or receiver is active. <b>SPEED:</b> This LED is ON when the Ethernet connection is 100 Mb/s and OFF when it is 10 Mb/s. For Firmware version prior to 5.0.00: <b>LINK:</b> Green LED indicates a network link is present <b>RX:</b> Flashes green in response to data reception <b>TX:</b> Flashes green in response to data transmission <b>MODBUS:</b> <b>TX1:</b> Green blinks when Transmit activity on MODBUS 1 occurs; Off when no Transmit activity on MODBUS 1;</p>	<p><b>Data Logger</b> Records up to 64,000 time-stamped data points; minimum sample period, 100msec; maximum sample period, 24 hour <b>Real Time Clock (RTC):</b> ±1 minute/month (when not using SNTP to synchronize to a network time server); Non-volatile memory holds time-stamped data; measurement parameters are software configurable; 18,000 data points stored in BBRAM</p> <p><b>Ambient Conditions</b> <b>Operating Range:</b> -40°C to +85°C (-40°F to +185°F) <b>Storage Range:</b> -40°C to +85°C (-40°F to +185°F) <b>Relative Humidity:</b> 0-95%, non-condensing <b>Ambient Temperature Effect:</b> 0.01% of maximum span/°C <b>RFI/EMI Protection:</b> 20V/m@80-1000MHz, 1kHz AM when tested according to EN61326 with errors of 0.5% or span or less <b>Normal Mode:</b> 60dB typical@20mA peak-to-peak, 50/60Hz</p> <p><b>Weight</b> 612 g (21.6 oz)</p>

## Specifications (continued)

### AIM Analog Input Module (4 Channels)

Up to 16 Per Interface Module

<p><b>Performance</b></p> <p><b>Input Ranges:</b> Programmable for any range within: Current, 0-25mA (4mA minimum span) or Voltage, -10V to +10V (1V minimum span) <b>Accuracy:</b> ±0.01% of maximum span <b>Input Resolution:</b> 20-bit <b>Stability (% of max. span):</b> Current: 1-year, 0.047%; 3-year, 0.081%; 5-year, 0.11% Voltage: 1-year, 0.066%; 3-year, 0.11%; 5-year, 0.15% <b>Isolation:</b> 500Vrms, continuous, from channel to channel, from each channel to case, and from each channel to terminals of other attached NCS modules; will withstand 1000Vrms dielectric strength test for one minute, with no breakdown, from each channel to case, and from each channel to terminals of other attached NCS modules</p>	<p><b>Performance (continued)</b></p> <p><b>Scan Time:</b> The time required for the Interface Module to access process variable and status data from all four channels of the AIM is 16ms <b>Response Time:</b> 60ms <b>Input Impedance:</b> Current, 20ohms; Voltage, 1Mohm <b>Maximum Input Overrange:</b> Current, ±100mA; Voltage, ±30V <b>Power Supply:</b> Power is supplied by the Interface Module, 4W maximum <b>Input Filter:</b> User-Programmable for 50Hz or 60Hz noise rejection <b>Linearization Capability:</b> Custom curve tables can be configured with up to 128 points using Internet Explorer web pages or PC-based software <b>Transmitter Excitation:</b> 21V/24mA excitation for powering a 2-wire transmitter <b>Diagnostic Information:</b> Status data available when polling channels includes A/D saturated; input signal out of linearized range; EEPROM failure; A/D converter failure; and run-time failure</p>	<p><b>Status and Fault Indicators</b> One red/green LED per channel indicates proper channel operation (green) or that the channel is in a fault condition (red)</p> <p><b>Ambient Conditions</b></p> <p><b>Operating Range:</b> -40°C to +85°C (-40°F to +185°F) <b>Storage Range:</b> -40°C to +85°C (-40°F to +185°F) <b>Ambient Temperature Effect:</b> 0.01% of maximum span/°C <b>Relative Humidity:</b> 0-95%, non-condensing <b>RFI/EMI Protection:</b> 20V/m @ 20-1000MHz, 1kHz AM when tested according to ENC61000-4-3-1996. <b>Common Mode Rejection:</b> 100dB @ 50/60Hz <b>Normal Mode Rejection:</b> Current, 60dB typical @ 10mA peak-to-peak; Voltage, 60dB typical @ 1V peak-to-peak, 50/60Hz</p> <p><b>Vibration</b> As defined by SAMA PCM 31.1, field mounted category</p> <p><b>Weight</b> 562 g (19.8 oz)</p>
---	---	--

## Advanced Control and Math

Using **ISaGRAF Control Engine Software** from **Rockwell Automation**, the NET Concentrator System can be configured to deliver additional architecture, control, computation and functional capabilities including:

- The ability to act as a single or multiple PID loop controller with simple, cascade, split action and inverse capabilities.
- Sequential control language programmability based on IEC 61131-3, including ladder, function block diagram and structured text.
- Complex math capabilities including add, subtract, multiply and divide; absolute value; square root; integrate and totalize; exponential; natural logarithm; base<sub>10</sub> logarithm; comparison; sine, cosine and tangent; arc sine, arc cosine and arc tangent.
- Highly functional peer-to-peer\* configurations that allow "Free Channel Mapping" and "Sending a Process Signal to Multiple Locations."

The ISaGRAF workbench software is available from Moore Industries for use in configuring custom applications. Alternatively, Moore Industries provides application development services for cost-effective integration of the ISaGRAF functions with the NCS. Consult the factory for details.

### Multipoint Analog Alarm (-MAA Option)

For simple Alarming requirements we have added a flexible alarm application that is configured through the on-board web server. This enables you to easily configure from one to 32 alarms, each alarm can be assigned to one input. Alarm settings include input source, trip point, high/low, relay assignment (optional) and deadband. With the installed ROM, alarms can also be directed to any of the 8 relays allowing alarms to be grouped or singled out.

\* Ethernet Peer-to-Peer Systems are accomplished using the EMM Interface Module combined with ISaGRAF control software (available from Moore Industries). MODBUS Peer-to-Peer Systems are configured via the EMM Interface Module internal Internet Explorer Web browser or using the Moore Industries software package called NCS Config. MODBUS RTU Master (and Slave) serial port setups use the EMM configuration tools. MODBUS RTU Master additionally uses the 'schedule.ini' file.

## Specifications (continued)

### AOM Analog Output Module (4 Channels)

Up to 16 per Interface Module

<b>Performance</b>	<p><b>Output Ranges:</b> Programmable for any range within: Current (sink or source), 0-23.6mA or Voltage, 0-11V</p> <p><b>Accuracy:</b> ±0.015% of maximum span</p> <p><b>Output Resolution:</b> 18-bit</p> <p><b>Stability (% of max. span):</b> Current: 1-year, 0.012%; 3-year, 0.020%; 5-year, 0.026%</p> <p>Voltage: 1-year, 0.066%; 3-year, 0.11%; 5-year, 0.15%</p> <p><b>Isolation:</b> 500Vrms, continuous, from channel to channel, from each channel to case, and from each channel to terminals of other attached NCS modules; will withstand 1000Vrms dielectric strength test for one minute, with no breakdown, from each channel to case, and from each channel to terminals of other attached NCS modules</p> <p><b>Scan Time:</b> The time required for the Interface Module to access process variable and status data from all four channels of the AOM is 16ms</p> <p><b>Response Time:</b> 50ms to 90% of final value on a step input</p>	<b>Performance (continued)</b>	<p><b>Output Damping:</b> Increases response time by adjusting filter time constant from 0-30 seconds</p> <p><b>Ripple:</b> Current, 10mV peak-to-peak measured across a 250ohm load resistor; Voltage, 50mV peak-to-peak maximum</p> <p><b>Load Capability:</b> Current, 0-1000ohms (source), 42V maximum (sink) 1500ohms; Voltage, 0-5mA (2000ohms minimum load)</p> <p><b>Output Limiting:</b> Current output is guaranteed up to 21.6mA (or 10% of full scale above the programmed full value) and limits at 23.6mA; Voltage output accuracy is guaranteed up to 10.5V (or 5% of full scale above the programmed full value) and limits at 11.0V</p> <p><b>Load Effect (current outputs):</b> 0.01% of span from 0 to maximum load resistance on current output</p> <p><b>Output Failure Mode:</b> Outputs are programmable to either hold last value or go to a pre-defined value on error upon lost communication with the Interface Module or upon receiving invalid primary variable data</p>	<b>Performance (continued)</b>	<p><b>Power Supply:</b> Power is supplied by the Interface Module, 4W maximum</p> <p><b>Diagnostic Information:</b> Status data available when polling channels includes ROM failure; RAM failure; EEPROM; open current output; EEPROM checksum error</p> <p><b>Status and Fault Indicators</b> One red/green LED per channel indicates proper channel operation (green) or that the channel is in a fault condition (red)</p> <p><b>Ambient Conditions</b> <b>Operating Range:</b> -40°C to +85°C (-40°F to +185°F) <b>Storage Range:</b> -40°C to +85°C (-40°F to +185°F) <b>Ambient Temperature Effect:</b> 0.01% of maximum span/°C <b>Relative Humidity:</b> 0-95%, non-condensing <b>RF/EMI Protection:</b> 20V/m@20-1000MHz, 1kHz AM when tested according to ENC61000-4-3-1996</p> <p><b>Vibration</b> As defined by SAMA PCM 31.1, field mounted category</p> <p><b>Weight</b> 765 g (27 oz)</p>
--------------------	--	--------------------------------	---	--------------------------------	---

## Versatile Data Link Options

In addition to Ethernet or twisted wire pair (for MODBUS RTU), versatile third-party communication link devices overcome long-distance, normally impassable, and hazardous environments (see Page 16 for additional information).

**Wireless (Radio)**—Where wires can't be run for practical or economic reasons, spread spectrum wireless radio (RF) communication equipment can be applied to provides accurate and reliable connectivity between sites. Distances between radios can be up to 20 miles, and repeaters can extend coverage even further.

**Cellular Modem**—Use a cellular modem to inexpensively transmit process data unlimited distances over cellular networks.

**Fiber Optic Cable**—For hazardous or exceptionally noisy environments, light is an effective strategy. Ethernet-to-Fiber or Serial-to-Fiber converters can be used to take advantage of your fiber networks.

**Redundant Communication Links**—For applications where you can't afford to lose data, the NET Concentrator System EMM Interface Module provides redundant RS-485 communication links as standard for connecting a backup digital communications link. The redundant link can be implemented in both peer-to-host systems and peer-to-peer systems. The secondary communications link is independent of the primary link. If the primary link is severed or otherwise compromised, data transmission will continue within the NET Concentrator System network.

## Specifications (continued)

### TIM Temperature Input Module (4 Channels)

Up to 16 Per Interface Module

<p><b>Performance</b></p> <p><b>Input Ranges:</b> See Table 1  <b>Accuracy:</b> See Table 1  <b>Reference Junction Compensation Accuracy:</b> ±0.45°C  <b>Input Resolution:</b> 20-bit  <b>Stability (% of max. span):</b>          RTD:          1-year, 0.013%;          3-year, 0.023%;          5-year, 0.029%          Thermocouple:          1-year, 0.0084%;          3-year, 0.015%;          5-year, 0.019%  <b>Isolation:</b> 500Vrms, continuous, from channel to channel, from each channel to case, and from each channel to terminals of other attached NCS modules; will withstand 1000Vrms dielectric strength test for one minute, with no breakdown, from each channel to case, and from each channel to terminals of other attached NCS modules  <b>Scan Time:</b> The time required for the Interface Module to access process variable and status data from all four channels of the TIM is 16ms  <b>Response Time:</b> 150ms</p>	<p><b>Performance (continued)</b></p> <p><b>Input Impedance (T/C):</b> 40Mohms, nominal  <b>Maximum Input Overrange:</b> ±5Vdc peak, maximum  <b>Excitation Current (RTD and Ohms):</b> 250 microamps nominal  <b>Power Supply:</b> Power is supplied by the Interface Module, 1.5W maximum  <b>Linearization Capability:</b> Custom curve tables can be configured with up to 128 points using Internet Explorer web pages or PC-based software  <b>Input Filter:</b> Programmable for 50 or 60Hz noise rejection  <b>Diagnostic Information:</b> Status data available when polling channels includes A/D saturated; input signal out of linearized range; broken RJC; broken sensor wire (#1, #2, #3, or #4); run-time failure; EEPROM failure; A/D converter fail</p> <p><b>Status and Fault Indicators</b> One red/green LED per channel indicates proper channel operation (green) or that the channel is in a fault condition (red)</p>	<p><b>Ambient Conditions</b></p> <p><b>Operating Range:</b> -40°C to +85°C (-40°F to +185°F)  <b>Storage Range:</b> -40°C to +85°C (-40°F to +185°F)  <b>Ambient Temperature Effect:</b> See Table 1  <b>Effect on Reference Junction Compensation:</b> ±0.005°C/°C  <b>Relative Humidity:</b> 0-95%, non-condensing  <b>RFI/EMI Immunity:</b> 20V/m @20-1000MHz, 1kHz AM when tested according to ENC6100-4-3-1996; Effect on RTD/ohms Input: 0.4°C/0.1ohms, maximum; Effect on Thermocouple/Millivolt Input: 1.0°C/40µV, maximum  <b>Common Mode Rejection:</b> 100dB @50/60Hz  <b>Normal Mode Rejection:</b> 50dB typical @0.2V peak-to-peak, 50/60Hz</p> <p><b>Vibration</b> As defined by SAMA PCM 31.1, field mounted category</p> <p><b>Weight</b> 589 g (20.7 oz)</p>
--	--	---

### Temperature Measurement Advantages

We've drawn on years of temperature measurement experience to produce the most stable, accurate and functional measurements available from an I/O system.

**“Total Sensor Diagnostics”**—This patented Moore Industries feature can save you from costly lost production time and hours of troubleshooting. If the sensor breaks or otherwise stops sending a signal during operation, data is made available via the MODBUS registers. The NCS also provides a plain-English error message that can be read from the system's PC web pages. If the sensor being utilized is an RTD, the web pages will display the type and location of the error.

### Trims to Read Specific Sensor Curve

**Segments**—Most temperature measurement devices can be calibrated to measure a specific range within

a sensor's overall curve capability. However, for even greater measurement accuracy, our interface's trim capabilities go much further. The NET Concentrator System's temperature input channels can be trimmed with two data points within the selected zero and span measurement range. This advantage allows a complete process range to be monitored, while placing measurement emphasis on a specific segment of the range most critical to the process.

**Precise Linearization and RJC**—The NCS uses an advanced linearization method to minimize the conformance error. Its Reference (Cold) Junction Compensation techniques produce stable readings even in fluctuating ambient temperature conditions. For non-linear inputs, create custom linearization curves using our web-based software.

**Table 1. TIM Temperature Input Module Input Types.**

Input	Type	$\alpha$	Ohms	Conformance Range	Minimum Span	Input Accuracy	Maximum Range	Ambient Temperature Accuracy/°C Change
RTD (2-, 3-, 4-Wire)	Platinum	0.003850	100	-200 to 850°C -328 to 1562°F	10°C (18°F)	±0.1°C (±0.18°F)	-240 to 960°C -400 to 1760°F	0.0035°C (0.0063°F)
			200					
			300					
			400					
			500					
		1000						
		0.003902	100	-100 to 650°C -148 to 1202°F			-150 to 720°C -238 to 1328°F	
			200					
			400					
			500					
1000								
0.003916	100	-200 to 510°C -328 to 950°F	-240 to 580°C -400 to 1076°F					
Nickel	0.00672	120	-80 to 320°C -112 to 608°F	±0.14°C (±0.25°F)	-100 to 360°C -148 to 680°F	0.002°C (0.0036°F)		
Copper	0.00427	9.035	-50 to 250°C -58 to 482°F	±1.6°C (±2.88°F)	-65 to 280°C -85 to 536°F	0.0035°C (0.0063°F)		
Ohms	Direct Resistance	n/a	0-4000ohms	0-4000ohms	10ohms	±0.4ohms	0-4095ohms	0.002ohms + 0.005% of reading
	Potentiometer		100-4000ohms	0-100%	10%	±0.1%	0-100%	
T/C	J	n/a	n/a	-180 to 760°C -292 to 1400°F	35°C (63°F)	±0.25°C (±0.45°F)	-210 to 770°C -346 to 1418°F	0.00016°C + 0.005% of reading
	K	n/a	n/a	-150 to 1370°C -238 to 2498°F	40°C (72°F)	±0.3°C (±0.54°F)	-270 to 1390°C -454 to 2534°F	0.0002°C + 0.005% of reading
	E	n/a	n/a	-170 to 1000°C -274 to 1832°F	35°C (63°F)	±0.25°C (±0.45°F)	-270 to 1013°C -454 to 1855.4°F	0.00026°C + 0.005% of reading
	T	n/a	n/a	-170 to 400°C -274 to 752°F	35°C (63°F)	±0.25°C (±0.45°F)	-270 to 407°C -454 to 764.6°F	0.0001°C + 0.005% of reading
	R	n/a	n/a	0 to 1760°C 32 to 3200°F	50°C (90°F)	±0.55°C (±0.99°F)	-50 to 1786°C -58 to 3246.8°F	0.00075°C + 0.005% of reading
	S	n/a	n/a	0 to 1760°C 32 to 3200°F	50°C (90°F)	±0.55°C (±0.99°F)	-50 to 1786°C -58 to 3246.8°F	0.00075°C + 0.005% of reading
	B	n/a	n/a	400 to 1820°C 752 to 3308°F	75°C (135°F)	±0.75°C (±1.35°F)	200 to 1836°C 392 to 3336.8°F	0.0038°C + 0.005% of reading
	N	n/a	n/a	-130 to 1300°C -202 to 2372°F	45°C (81°F)	±0.4°C (±0.72°F)	-270 to 1316°C -454 to 2400.8°F	0.0003°C + 0.005% of reading
	C	n/a	n/a	0 to 2300°C 32 to 4172°F	100°C (180°F)	±0.8°C (±1.44°F)	0 to 2338°C 32 to 4240.4°F	0.00043°C + 0.005% of reading
mV	DC	n/a	n/a	-50 to 1000mV	4mV	15µV	n/a	0.5µV + 0.005%



## Specifications (continued)

### DIM Discrete Contact Closure Input Module (8 Channels) Up to 16 Per Interface Module

<p><b>Performance</b> <b>Input Ratings:</b> Contact closure, 24V/3.7mA, internally powered <b>Input Logic Threshold:</b> 8V low-going; 16V high-going <b>Input Logic:</b> Closed contact input yields logic 1 <b>Isolation:</b> 500Vrms, continuous, from channel to channel, from each channel to case, and from each channel to terminals of other attached NCS modules; will withstand 1000Vrms dielectric strength test for one minute, with no breakdown, from each channel to case, and from each</p>	<p><b>Performance (continued)</b> channel to terminals of other attached NCS modules <b>Scan Time:</b> 16ms <b>Response Time:</b> &lt;12ms with contact debounce disabled <b>Power Supply:</b> Power is supplied by the Interface Module, 3W maximum <b>Diagnostic Information:</b> Status data available when polling channels, includes: ROM failure; RAM failure; EEPROM checksum error</p> <p><b>LED Indicators</b> One red/green LED per channel indicates input state, with red indicating open contact input</p>	<p><b>Ambient Conditions</b> <b>Operating Range:</b> -40°C to +85°C (-40°F to +185°F) <b>Storage Range:</b> -40°C to +85°C (-40°F to +185°F) <b>Relative Humidity:</b> 0-95%, non-condensing <b>RFI/EMI Protection:</b> 20V/m @20-1000MHz, 1kHz AM when tested according to IEC1000-4-3-1995</p> <p><b>Vibration</b> As defined by SAMA PCM 31.1, field mounted category</p> <p><b>Weight</b> 493 g (17.4 oz)</p>
---	---	---

### DIM Discrete Voltage Input Module (8 Channels) Up to 16 Per Interface Module

<p><b>Performance</b> <b>Input Ratings:</b> Low Range, 30Vac/Vdc; High Range: 120/240Vac/Vdc <b>Input Logic Threshold:</b> Low Range: &lt;9Vac or dc guaranteed low, &gt;15Vac or dc guaranteed high; High Range: &lt;55Vac or dc guaranteed low, &gt;90Vac or dc guaranteed high <b>Input Logic:</b> Input above threshold yields logic 1; Input below threshold yields logic 0 <b>Input Impedance:</b> Each input draws &lt;4mA when on <b>Isolation:</b> 500Vrms, continuous, from channel to channel, from each channel to case, and from each channel to terminals of other attached</p>	<p><b>Performance (continued)</b> NCS modules; will withstand 1000Vrms dielectric strength test for one minute, with no breakdown, from each channel to case, and from each channel to terminals of other attached NCS modules <b>Scan Time:</b> 16ms <b>Response Time:</b> &lt;30ms <b>Maximum Input Overrange:</b> Up to 260Vac/Vdc <b>Power Supply:</b> Power is supplied by the Interface Module, 1W maximum <b>Diagnostic Information:</b> Status data available when polling channels, includes: ROM failure; RAM failure; EEPROM checksum error</p>	<p><b>LED Indicators</b> One red/green LED per channel indicates input state, with red indicating input below threshold</p> <p><b>Ambient Conditions</b> <b>Operating Range:</b> -40°C to +85°C (-40°F to +185°F) <b>Storage Range:</b> -40°C to +85°C (-40°F to +185°F) <b>Relative Humidity:</b> 0-95%, non-condensing <b>RFI/EMI Protection:</b> 20V/m @20-1000MHz, 1kHz AM when tested according to IEC1000-4-3-1995</p> <p><b>Vibration</b> As defined by SAMA PCM 31.1, field mounted category</p> <p><b>Weight</b> 536 g (18.8 oz)</p>
---	--	---

### ROM Relay Output Module (8 Channels) Up to 16 Per Interface Module

<p><b>Performance</b> <b>Mechanical Output Ratings:</b> 8-Channel Model: SPST relay, 1 form A or B, rated 2A@250Vac, 50/60Hz, or 2A@30Vdc, non-inductive <b>Output Logic:</b> Logic 1 yields energized relay <b>Output Failure Mode:</b> Outputs are programmable to either hold last value, or go energized or de-energized upon lost communication with the interface module <b>Scan Time:</b> 16ms <b>Isolation:</b> 500Vrms, continuous, from channel to channel, from each channel to case, and from each channel to terminals of other attached</p>	<p><b>Performance (continued)</b> NCS modules; will withstand 1000Vrms dielectric strength test for one minute, with no breakdown, from each channel to case, and from each channel to terminals of other attached NCS modules <b>Response Time:</b> &lt;10ms <b>Power Supply:</b> Power is supplied by the interface module, 3W maximum <b>Diagnostic Information:</b> Status data available when polling channels, includes: ROM failure; RAM failure; EEPROM checksum error</p> <p><b>LED Indicators</b> One red/green LED per channel indicates relay state and can be programmed for desired sense</p>	<p><b>Ambient Conditions</b> <b>Operating Range:</b> -40°C to +85°C (-40°F to +185°F) <b>Storage Range:</b> -40°C to +85°C (-40°F to +185°F) <b>Relative Humidity:</b> 0-95%, non-condensing <b>RFI/EMI Protection:</b> 20V/m @20-1000MHz, 1kHz AM when tested according to IEC1000-4-3-1995</p> <p><b>Vibration</b> As defined by SAMA PCM 31.1, field mounted category</p> <p><b>Weight</b> 493 g (17.4 oz)</p>
---	---	---

## Specifications (continued)

### CPM Power Supply Module

One Or More Required Per NET Concentrator System Station if There Are More Than Two Input/Output Modules

<p><b>Performance</b></p> <p><b>Inputs (Power):</b> 20-30Vdc</p> <p><b>Output (Power):</b> Each CPM provides power to up to eight NCS I/O modules</p> <p><b>Isolation:</b> 500Vrms, continuous, and will withstand 1000Vrms dielectric strength test for 1 minute with no breakdown, between power input, each MODBUS port, case and terminals of other attached NCS modules</p> <p><b>Startup Time:</b> 10ms</p> <p><b>Power Consumption:</b> 40W maximum</p>	<p><b>Power and Status Indicators</b></p> <p><b>Power LED:</b> A green LED turns on to indicate that power is being supplied to the power terminals.</p> <p><b>Status LED:</b> A green LED turns on to indicate that power is available at the CPM module's output</p> <p><b>Ambient Conditions</b></p> <p><b>Operating Range:</b> -40°C to +85°C (-40°F to +185°F)</p> <p><b>Storage Range:</b> -40°C to +85°C (-40°F to +185°F)</p>	<p><b>Ambient Conditions (continued)</b></p> <p><b>Relative Humidity:</b> 0-95%, non-condensing</p> <p><b>RFI/EMI Protection:</b> 20V/m @ 20-1000MHz, 1kHz AM when tested according to ENC61000-4-3-1996</p> <p><b>Vibration</b> As defined by SAMA PCM 31.1, field mounted category</p> <p><b>Weight</b> 585 g (20.7 oz)</p>
--	---	---

Figure 9. Installation Dimensions.

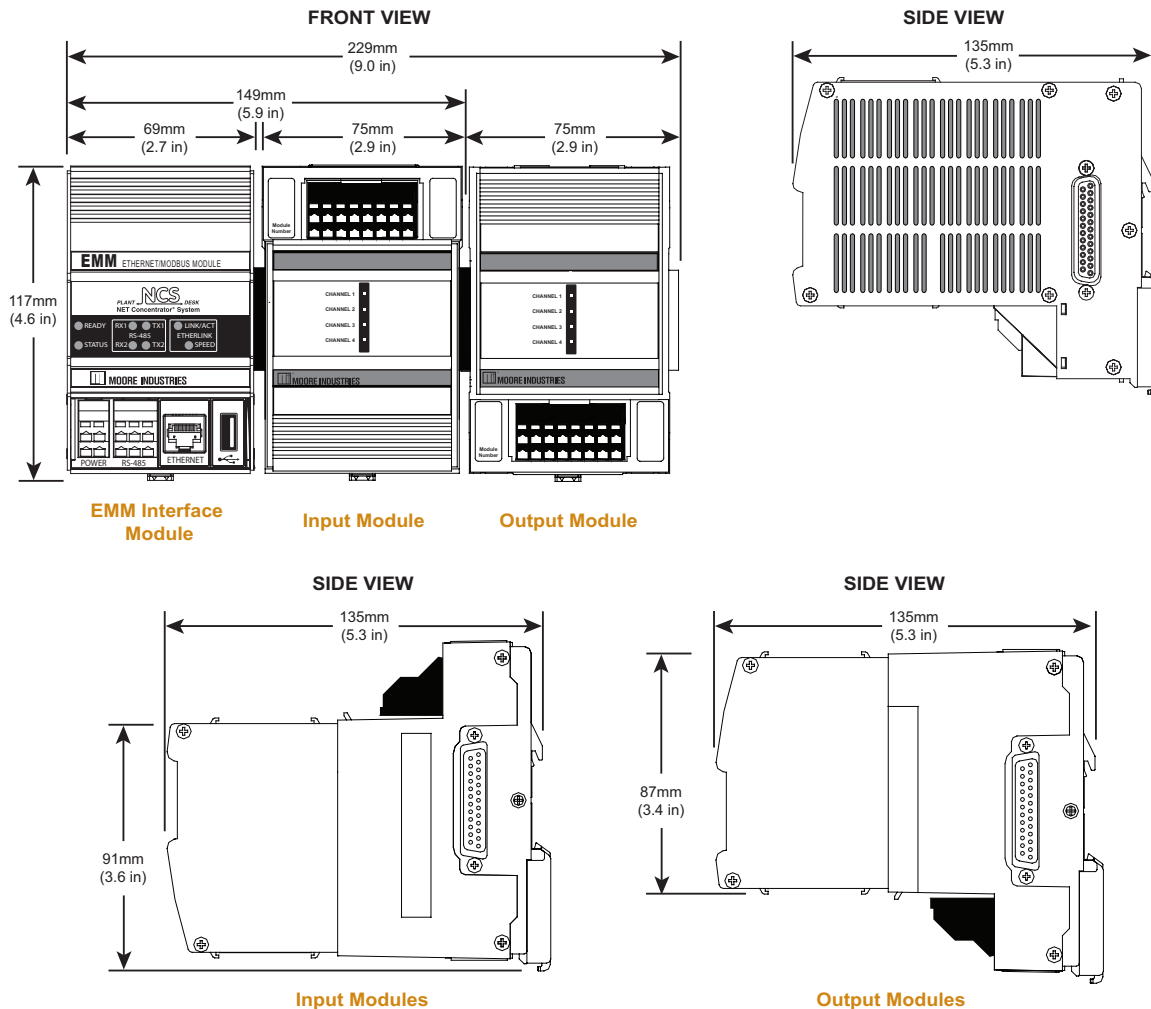

# NCS

NET Concentrator System®  
Process Control and Distributed I/O

## Certifications



**Factory Mutual – FM Approvals –  
cFMus (US/Canada), Non-Incendive –**  
Class I, Division 2, Groups A, B, C, D  
T4A@40°C, T4@60°C, T3C@85°C Max. Op. Ambient  
For use in General Locations and/or Hazardous  
'Classified' Locations when mounted in protective and  
suitable enclosures



**CE Conformant – EMC Directive 2014/30/EU EN61326;  
Low Voltage Directive 2014/35/EU EN61010**

## System Accessories

The following technology is available from 3rd parties.

### Industrial Ethernet Switches

Intelligent multi-port communications switches automatically determine and remember where a NET Concentrator System Station is located, and routes messages only through the appropriate port to that Station. This minimizes network loading and improves deterministic communications over Ethernet.

### Ethernet Routers

Connects multiple NET Concentrator System segments or sub-networks, forwards messages from one network to another, and provides message traffic isolation between segments.

### RS-485 to RS-232C/RS-422 Converter

For MODBUS (RS-485) networks, converts the RS-485 signal to either RS-232C or RS-422 standard to allow direct interface with a modem or computer-based systems, such as a PC.

### RS-485 to Fiber Optics Converter

Converts the NCS's RS-485 signal to light for signal transmission over a fiber optic cable.

### Ethernet/RS-485 Repeater

Repeaters are available to extend the typical reach of Ethernet and RS-485.

### Wireless RF Modems

Where wires can't be run for practical or economic reasons, spread spectrum wireless radio (RF) communication provides accurate and reliable connectivity between sites. Distances between modems can be up to 20 miles, and repeaters can extend coverage even further.

### Short Haul Modem

Some short haul modems convert to a different signal type to gain greater distances over copper.

### Data Line (Surge) Protectors

Mounts next to the NCS to protect the data link from damaging voltage and current surges caused by lightning, welding, heavy electrical equipment and switch gears.

### Instrument Power Supplies

Moore Industries offers a complete line of instrument power supplies for mounting alongside and powering the NET Concentrator System.

### Redundant Power Supply

DIN-style, rail-mount module accepts two power supply inputs and provides an uninterrupted power source by passing the highest voltage.



United States • info@miinet.com  
Tel: (818) 894-7111 • FAX: (818) 891-2816  
Australia • sales@mooreind.com.au  
Tel: (02) 8536-7200 • FAX: (02) 9525-7296

*Demand Moore Reliability*

**www.miinet.com**

BeNeLux • info@mooreind.eu  
Tel: 03/448.10.18 • FAX: 03/440.17.97

China • sales@mooreind.sh.cn  
Tel: 86-21-62491499 • FAX: 86-21-62490635  
United Kingdom • sales@mooreind.com  
Tel: 01293 514488 • FAX: 01293 536852